

# BRCS035N03DPQ

Rev.A Dec.-2023

## 描述 / Descriptions

TO-252 塑封封装 N 沟道 MOS 场效应管。

N-Channel Enhancement Mode Field Effect Transistor in a TO-252 Plastic Package.

## 特征 / Features

$V_{DS} (V) = 30V$   $I_D = 122 A (V_{GS} = \pm 20V)$

$R_{DS(ON)}@10V \leq 3.5mR (Typ. 3.4mR)$

$R_{DS(ON)}@4.5V \leq 6.5mR (Typ. 5.0mR)$

符合 AEC-Q101 标准高可靠性要求，无卤产品。Qualified to AEC-Q101 Standards for High Reliability, HF Product.

## 用途 / Applications

负载开关应用、电池电源管理，满足汽车应用的严格要求。

Load Switch Applications, Battery Power Management, Meet the stringent requirements of automotive applications.

## 内部等效电路 / Equivalent Circuit

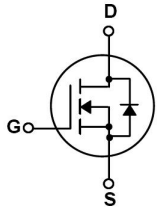

## 引脚排列 / Pinning

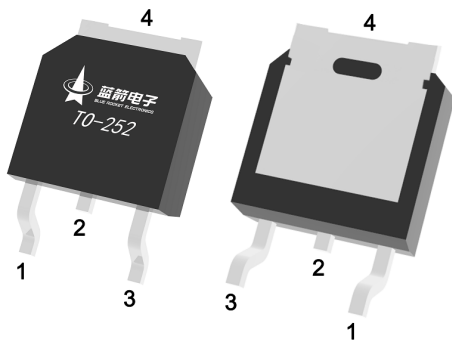

PIN1 : G

PIN 2、4 : D

PIN 3 : S

## 印章代码 / Marking

见印章说明。

See Marking Instructions.

**极限参数 / Absolute Maximum Ratings(Ta=25°C)**

参数 Parameter	符号 Symbol	数值 Rating	单位 Unit
Drain-Source Voltage	V <sub>DSS</sub>	30	V
Drain Current	I <sub>D</sub> (Tc=25°C)	122	A
Drain Current - Pulsed	I <sub>DM</sub>	260	A
Gate-Source Voltage	V <sub>GSS</sub>	±20	V
Single Pulsed Avalanche Energy	E <sub>AS</sub>	281	mJ
Avalanche Current	I <sub>AS</sub>	26.5	A
Power Dissipation	P <sub>D</sub> (Tc=25°C)	88	W
Operating and Storage Temperature Range	T <sub>J</sub> , T <sub>stg</sub>	-55 to 150	°C
Junction-to-Ambient	t ≤ 10	22	°C/W
Junction-to-Ambient	Steady-State	50	
Junction-to-Case	Steady-State	1.42	

**电性能参数 / Electrical Characteristics(Ta=25°C)**

参数 Parameter	符号 Symbol	测试条件 Test Conditions	最小值 Min	典型值 Typ	最大值 Max	单位 Unit
Drain-Source Breakdown Voltage	BV <sub>DSS</sub>	V <sub>GS</sub> =0V I <sub>D</sub> =250μA	30	33		V
Zero Gate Voltage Drain Current	I <sub>DSS</sub>	V <sub>DS</sub> =30V V <sub>GS</sub> =0V			1	μA
Gate-Body Leakage Current Forward	I <sub>GSS</sub>	V <sub>GS</sub> =±20V V <sub>DS</sub> =0V			±0.1	μA
Gate Threshold Voltage	V <sub>GS(th)</sub>	V <sub>DS</sub> =V <sub>GS</sub> I <sub>D</sub> =250μA	1.0	1.7	3.0	V
Static Drain-Source On-Resistance	R <sub>DS(on)1</sub>	V <sub>GS</sub> =10V I <sub>D</sub> =20A		3.4	3.5	mΩ
	R <sub>DS(on)2</sub>	V <sub>GS</sub> =4.5V I <sub>D</sub> =10A		5.0	6.5	mΩ
Drain-Source Diode Forward Voltage	V <sub>SD</sub>	V <sub>GS</sub> =0V I <sub>S</sub> =1A			1.4	V
Input Capacitance	C <sub>iss</sub>	V <sub>DS</sub> =25V V <sub>GS</sub> =0V f=1MHz		2200		pF
Output Capacitance	C <sub>oss</sub>			145		
Reverse Transfer Capacitance	C <sub>rss</sub>			210		
Gate resistance	R <sub>g</sub>	V <sub>GS</sub> =0V V <sub>DS</sub> =0V f=1MHz		2.0		Ω

## 电性能参数 / Electrical Characteristics(Ta=25°C)

参数 Parameter	符号 Symbol	测试条件 Test Conditions	最小值 Min	典型值 Typ	最大值 Max	单位 Unit
Total Gate Charge	$Q_{g(10V)}$	$V_{GS}=10V$ $V_{DS}=15V$ $I_D=20A$		32		nC
Total Gate Charge	$Q_{g(4.5V)}$			15		
Gate Source Charge	$Q_{gs}$			5.2		
Gate Drain Charge	$Q_{gd}$			6.5		
Turn-On Delay Time	$t_{d(on)}$	$V_{GS}=10V$ $V_{DS}=15V$ $R_L=0.75\ \Omega$ $R_{GEN}=3\ \Omega$		8.5		ns
Turn-On Rise Time	$t_r$			4.2		
Turn-Off Delay Time	$t_{d(off)}$			30		
Turn-Off Fall Time	$t_f$			5.7		

**电参数曲线图 / Electrical Characteristic Curve**

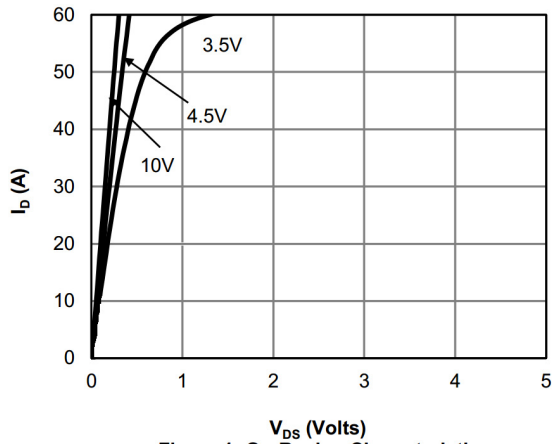

**Figure 1: On-Region Characteristics**

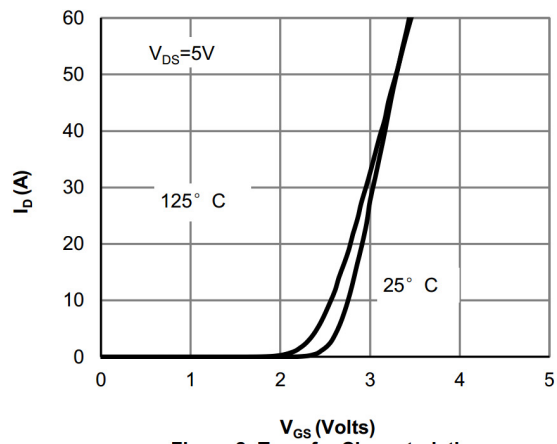

**Figure 2: Transfer Characteristics**

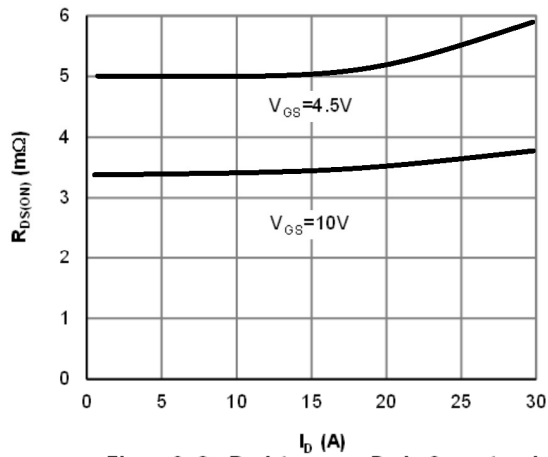

**Figure 3: On-Resistance vs. Drain Current and Gate Voltage**

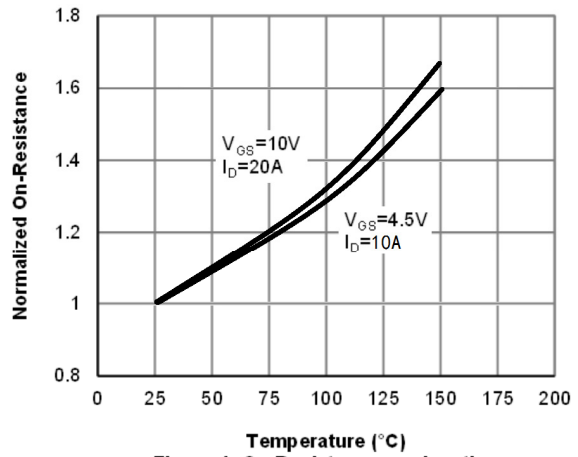

**Figure 4: On-Resistance vs. Junction Temperature**

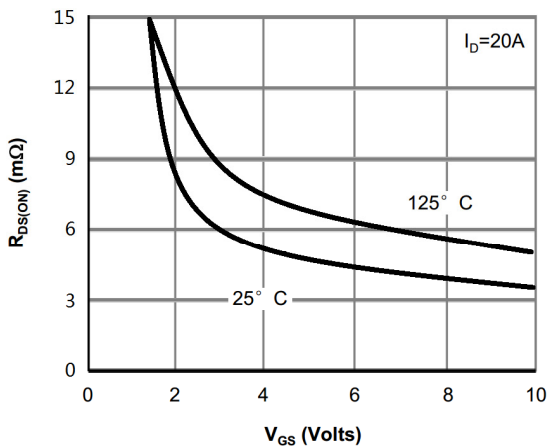

**Figure 5: On-Resistance vs. Gate-Source Voltage**

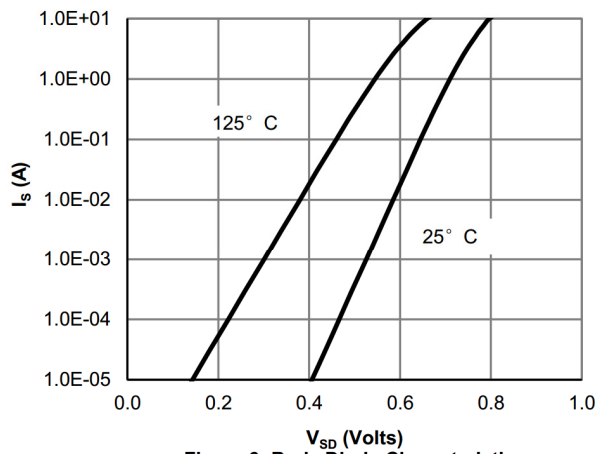

**Figure 6: Body-Diode Characteristics**

## 电参数曲线图 / Electrical Characteristic Curve

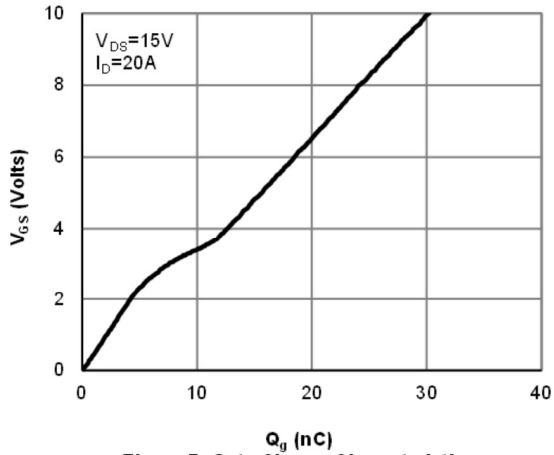

Figure 7: Gate-Charge Characteristics

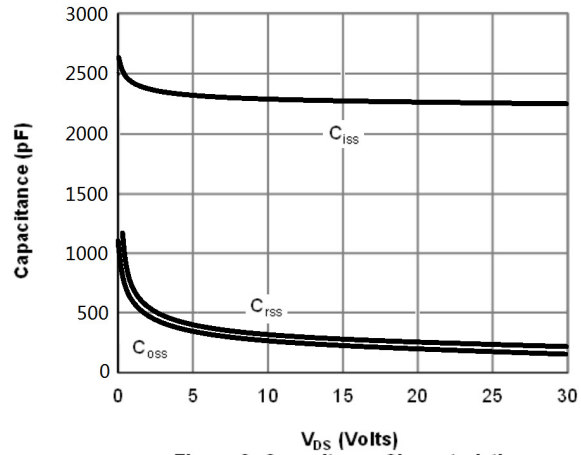

Figure 8: Capacitance Characteristics

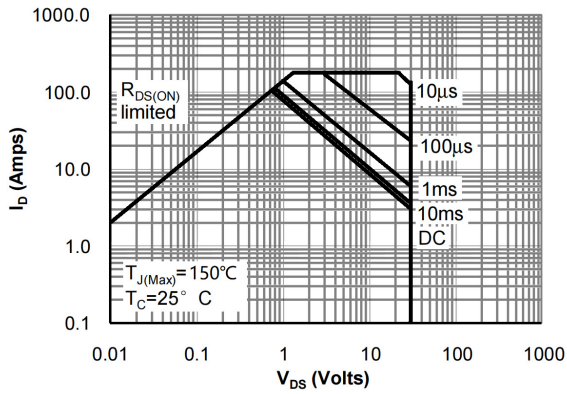

Figure 9: Maximum Forward Biased Safe Operating Area

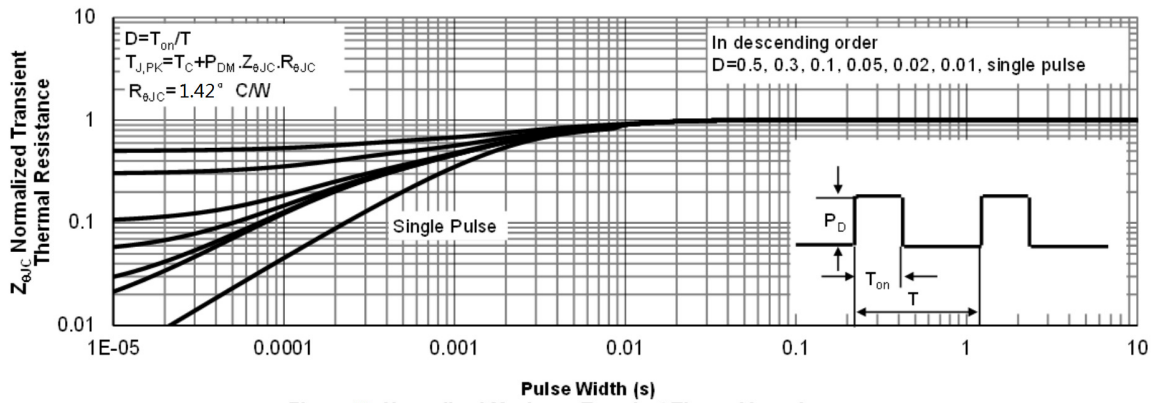
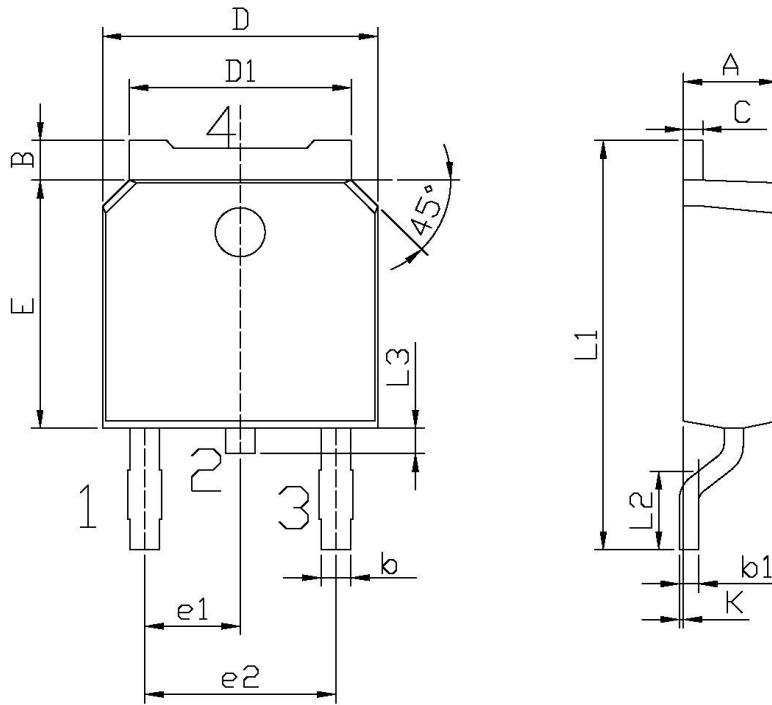

Figure 10: Normalized Maximum Transient Thermal Impedance

**外形尺寸图 / Package Dimensions**



单位: mm

Symbol	Dimensions In Millimeters		Symbol	Dimensions In Millimeters	
	Min	Max		Min	Max
A	2.20	2.40	E	5.95	6.25
B	0.95	1.25	e1	2.24	2.34
b	0.70	0.90	e2	4.43	4.73
b1	0.45	0.55	L1	9.85	10.35
C	0.45	0.55	L2	1.70	2.00
D	6.45	6.75	L3	0.60	0.90
D1	5.10	5.50	K	0.00	0.10

TO-252

**印章说明 / Marking Instructions**

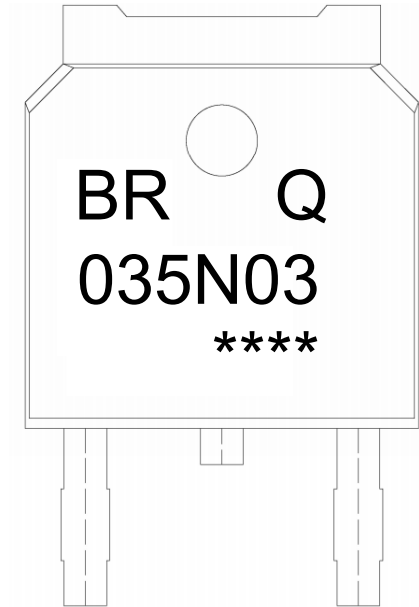

说明：

BR： 为公司代码

Q： 为汽车无卤产品标识

035N03： 为型号代码

\*\*\*\*： 为生产批号代码，随生产批号变化

Note:

BR: Company Code

Q: Automobile halogen-free product Code

035N03: Product Type Code

\*\*\*\*: Lot No. Code, code change with Lot No

**回流焊温度曲线图(无铅) / Temperature Profile for IR Reflow Soldering(Pb-Free)**

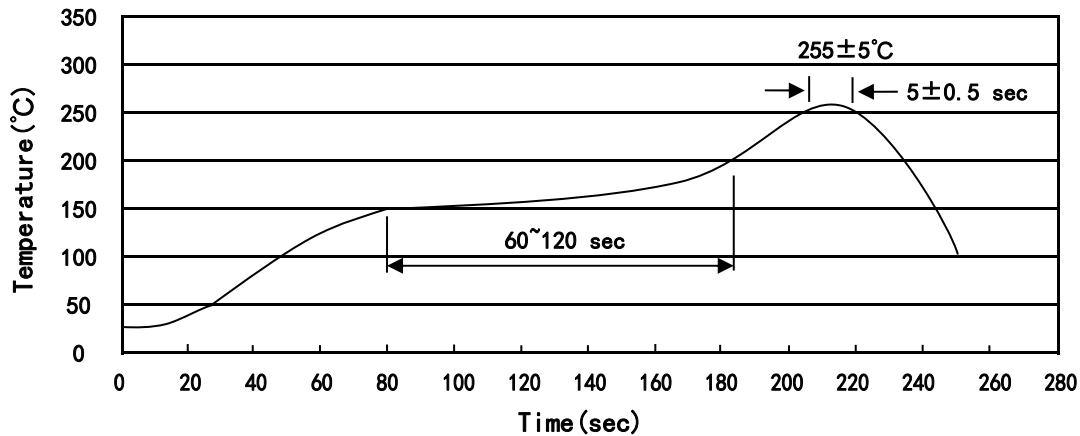

说明：

- 1、预热温度 150~200°C，时间 60~120sec;
- 2、峰值温度 255±5°C，时间持续为 5±0.5sec;
- 3、焊接制程冷却速度为 2~10°C/sec.

Note:

- 1.Preheating:150~200°C, Time:60~120sec.
- 2.Peak Temp.:255±5°C, Duration:5±0.5sec.
3. Cooling Speed: 2~10°C/sec.

**耐焊接热试验条件 / Resistance to Soldering Heat Test Conditions**

温度：260±5°C

时间：10±1 sec.

Temp.:260±5°C

Time:10±1 sec

**包装规格 / Packaging SPEC.**

卷盘包装 / REEL

Package Type 封装形式	Units 包装数量					Dimension 包装尺寸 (unit: mm <sup>3</sup> )		
	Units/Reel 只/卷盘	Reels/Inner Box 卷盘/盒	Units/Inner Box 只/盒	Inner Boxes/Outer Box 盒/箱	Units/Outer Box 只/箱	Reel	Inner Box 盒	Outer Box 箱
TO-252	2,500	2	5,000	6	30,000	13" ×16	360×360×50	380×335×366

套管包装 / TUBE

Package Type 封装形式	Units 包装数量					Dimension 包装尺寸 (unit: mm <sup>3</sup> )		
	Units/Tube 只/套管	Tubes/Inner Box 套管/盒	Units/Inner Box 只/盒	Inner Boxes/Outer Box 盒/箱	Units/Outer Box 只/箱	Tube 套管	Inner Box 盒	Outer Box 箱
TO-251/252	75	48	3,600	5	18,000	526×20.5×5.25	555×164×50	575×290×180

**使用说明 / Notices**