

# BRCS200P03DP

Rev.A Aug.-2022

## 描述 / Descriptions

TO-252 塑封封装 P 沟道 MOS 场效应管。  
P-CHANNEL MOSFET in a TO-252 Plastic Package.

## 特征 / Features

阻抗低，开关速度快，无卤产品。  
Low On-Resistance, fast switching, HF Product.

## 用途 / Applications

工业级DC/DC转换器的电源管理  
Power Management of Industrial DC/DC Converter.

## 内部等效电路 / Equivalent Circuit

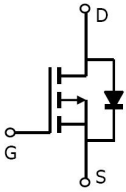

## 引脚排列 / Pinning

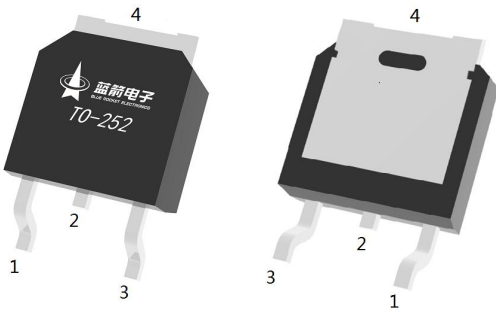

PIN 1 : G      PIN 2 : D      PIN 3 : S      PIN 4 : D

## 印章代码 / Marking

见印章说明。  
See Marking Instructions.

**极限参数 / Absolute Maximum Ratings( $T_a=25^{\circ}\text{C}$ )**

参数 Parameter	符号 Symbol	数值 Rating	单位 Unit
Drain-Source Voltage	$V_{DS}$	-30	V
Drain Current - Continuous	$I_D(T_c=25^{\circ}\text{C})$	-40	A
Drain Current – Pulsed	$I_{DM}$	-100	A
Gate-Source Voltage	$V_{GS}$	$\pm 20$	V
Power Dissipation	$P_D(T_c=25^{\circ}\text{C})$	62.5	W
Single Pulse Avalanche Energy(L=0.5mH)	$E_{AS}$	152	mJ
Avalanche Current(L=0.5mH)	$I_{AS}$	-19.5	A
Junction and Storage Temperature Range	$T_j, T_{stg}$	-55 to 150	$^{\circ}\text{C}$
Thermal resistance, junction - ambient	$t \leq 10\text{s}$	$R_{\theta JA}$	$^{\circ}\text{C/W}$
	Steady-State		
Thermal resistance, junction - case	Steady-State	$R_{\theta JC}$	2.0

**电性能参数 / Electrical Characteristics( $T_a=25^{\circ}\text{C}$ )**

参数 Parameter	符号 Symbol	测试条件 Test Conditions	最小值 Min	典型值 Typ	最大值 Max	单位 Unit
Drain-Source Breakdown Voltage	$BV_{DSS}$	$I_D=-250\mu\text{A}$ $V_{GS}=0\text{V}$	-30	-34		V
Zero Gate Voltage Drain Current	$I_{DSS}$	$V_{DS}=-30\text{V}$ $V_{GS}=0\text{V}$			-1	$\mu\text{A}$
Gate-Body leakage current	$I_{GSS}$	$V_{DS}=0\text{V}$ , $V_{GS}=\pm 20\text{V}$			$\pm 100$	nA
Gate Threshold Voltage	$V_{GS(th)}$	$V_{DS}=V_{GS}$ $I_D=-250\mu\text{A}$	-1	-1.3	-2.5	V
Static Drain-Source On-Resistance	$R_{DS(on)}$	$V_{GS}=-10\text{V}$ , $I_D=-20\text{A}$		19	22	m $\Omega$
		$V_{GS}=-4.5\text{V}$ , $I_D=-10\text{A}$		27	32	
Diode Forward Voltage	$V_{SD}$	$I_S=-1\text{A}$ , $V_{GS}=0\text{V}$			-1.2	V
Input Capacitance	$C_{iss}$	$V_{DS}=-25\text{V}$ $V_{GS}=0\text{V}$ $f=1.0\text{MHz}$		1430		pF
Output Capacitance	$C_{oss}$			580		
Reverse Transfer Capacitance	$C_{rss}$			350		
Gate resistance	$R_g$	$V_{GS}=0\text{V}$ $V_{DS}=0\text{V}$ $f=1\text{MHz}$		13		$\Omega$
Total Gate Charge	$Q_{g(10V)}$	$V_{GS}=-10\text{V}$ , $V_{DS}=-20\text{V}$ , $I_D=-20\text{A}$		31.2		nC
Total Gate Charge	$Q_{g(4.5V)}$			8.0		
Gate Source Charge	$Q_{gs}$			7.6		
Gate Drain Charge	$Q_{gd}$			6.3		

**电性能参数 / Electrical Characteristics(Ta=25°C)**

参数 Parameter	符号 Symbol	测试条件 Test Conditions	最小值 Min	典型值 Typ	最大值 Max	单位 Unit
Turn-On Delay Time	$t_{d(on)}$	$V_{GS}=-10V$ $V_{DS}=-20V$ $R_L=1.6\ \Omega$ $R_{GEN}=3\ \Omega$		10		ns
Turn-On Rise Time	$t_r$			18		
Turn-Off Delay Time	$t_{d(off)}$			39		
Turn-Off Fall Time	$t_f$			25		

**电参数曲线图 / Electrical Characteristic Curve**

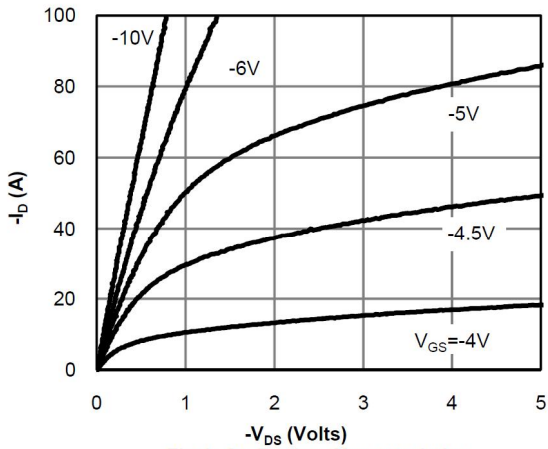

**Fig 1: On-Region Characteristics**

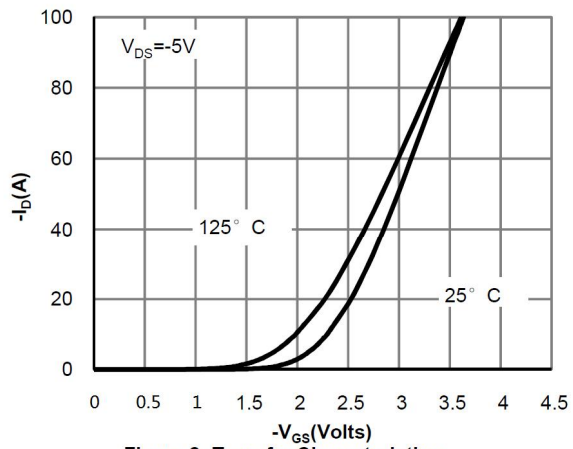

**Figure 2: Transfer Characteristics**

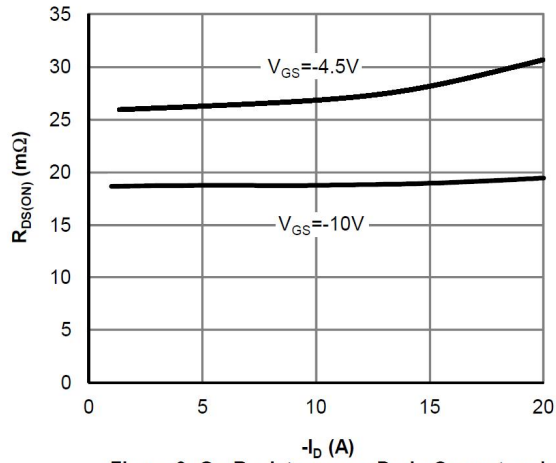

**Figure 3: On-Resistance vs. Drain Current and Gate Voltage**

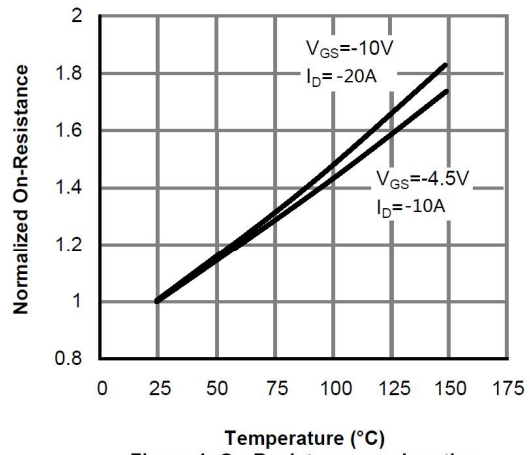

**Figure 4: On-Resistance vs. Junction Temperature**

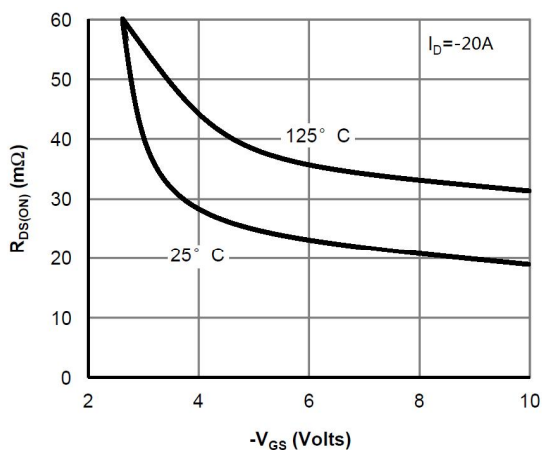

**Figure 5: On-Resistance vs. Gate-Source Voltage**

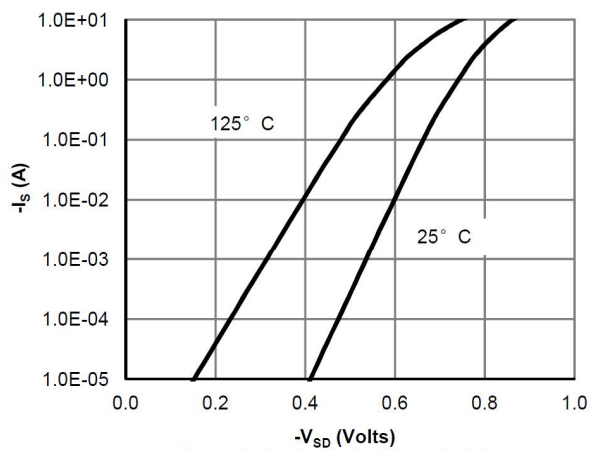

**Figure 6: Body-Diode Characteristics**

**电参数曲线图 / Electrical Characteristic Curve**

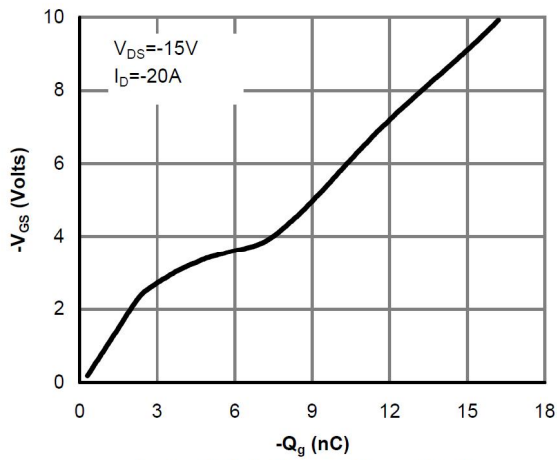

Figure 7: Gate-Charge Characteristics

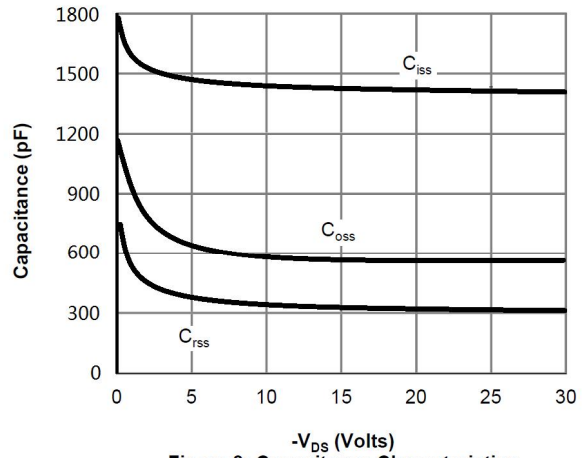

Figure 8: Capacitance Characteristics

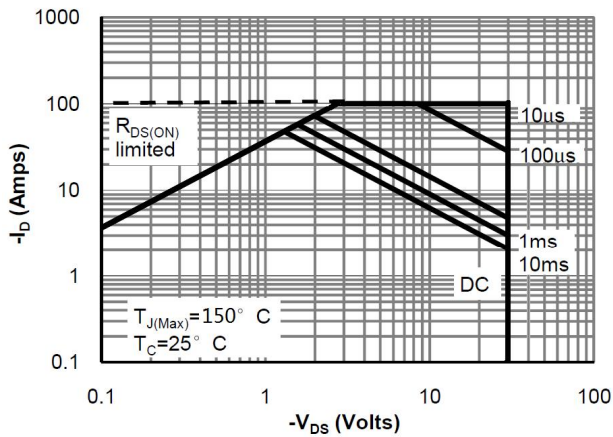

Figure 9: Maximum Forward Biased Safe Operating Area

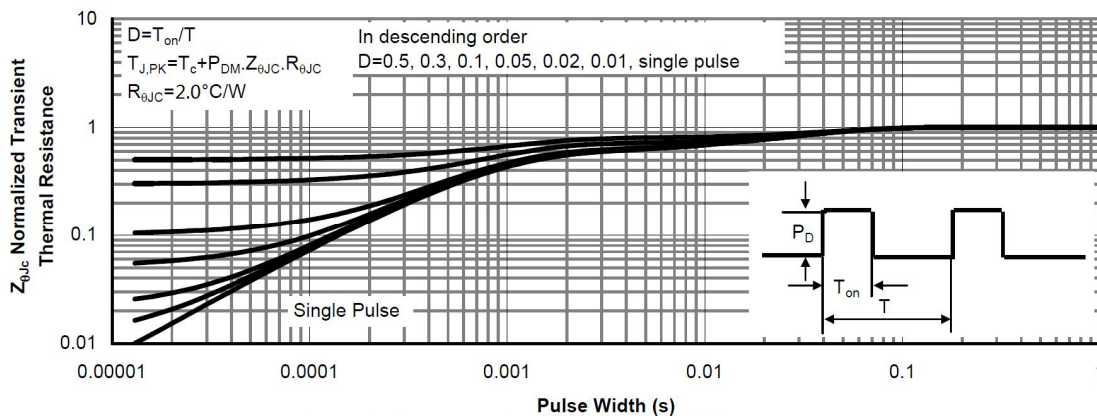
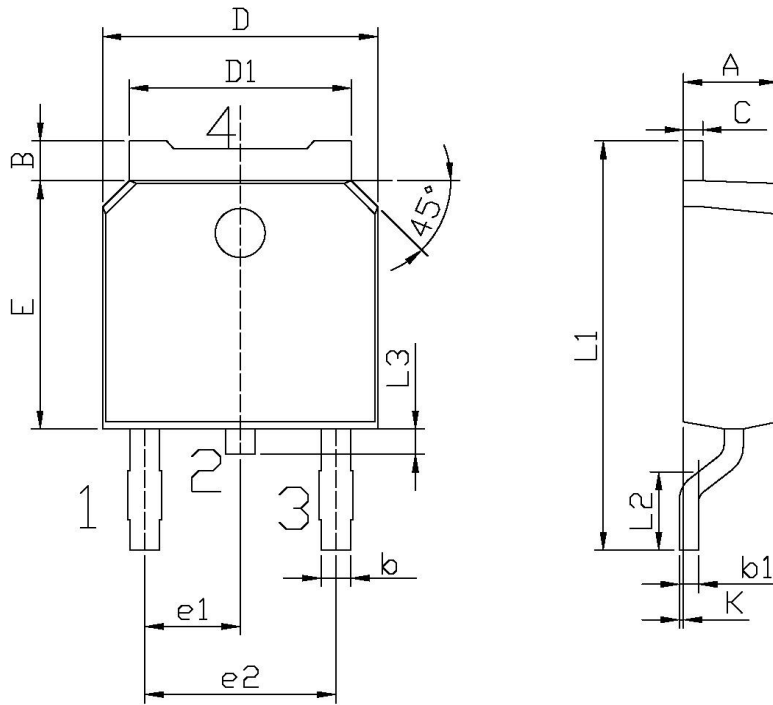

Figure 10: Normalized Maximum Transient Thermal Impedance

**外形尺寸图 / Package Dimensions**



单位：mm

Symbol	Dimensions In Millimeters		Symbol	Dimensions In Millimeters	
	Min	Max		Min	Max
A	2.20	2.40	E	5.95	6.25
B	0.95	1.25	e1	2.24	2.34
b	0.70	0.90	e2	4.43	4.73
b1	0.45	0.55	L1	9.85	10.35
C	0.45	0.55	L2	1.70	2.00
D	6.45	6.75	L3	0.60	0.90
D1	5.10	5.50	K	0.00	0.10

TO-252

**印章说明 / Marking Instructions**

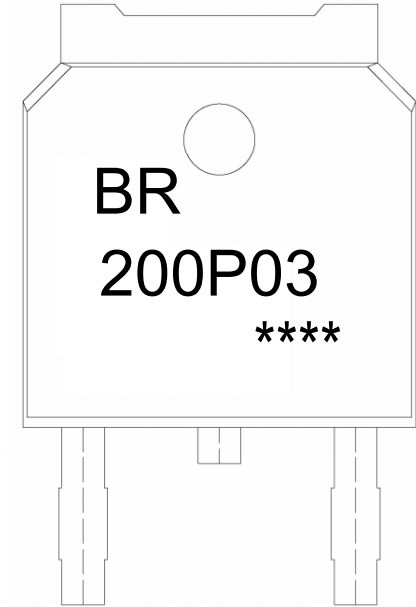

说明：

BR： 为公司代码

200P03： 为产品型号

\*\*\*\*： 为生产批号代码，随生产批号变化

Note:

BR: Company Code

200P03: Product Type

\*\*\*\*: Lot No. Code, code change with Lot No

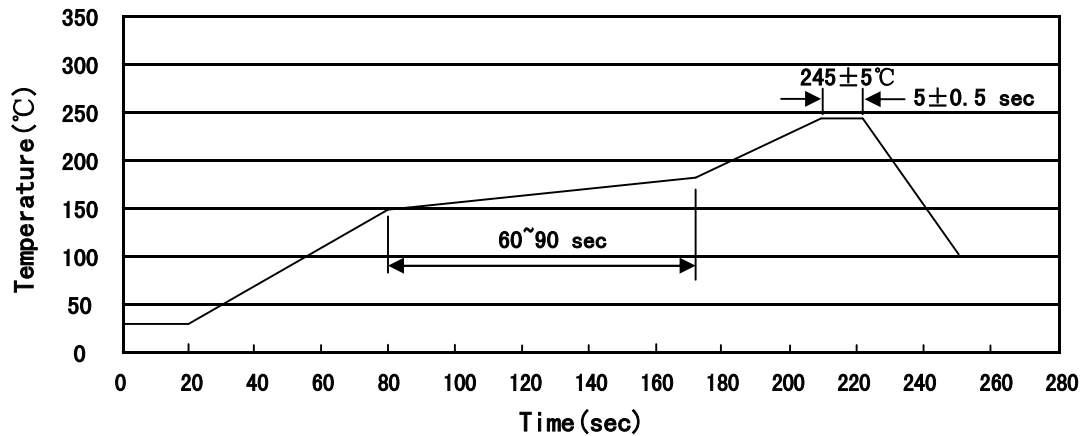
**回流焊温度曲线图(无铅) / Temperature Profile for IR Reflow Soldering(Pb-Free)**

说明：

- 1、预热温度 150~180°C，时间 60~90sec;
- 2、峰值温度 245±5°C，时间持续为 5±0.5sec;
- 3、焊接制程冷却速度为 2~10°C/sec.

Note:

- 1.Preheating:150~180°C, Time:60~90sec.
- 2.Peak Temp.:245±5°C, Duration:5±0.5sec.
3. Cooling Speed: 2~10°C/sec.

**耐焊接热试验条件 / Resistance to Soldering Heat Test Conditions**

温度：260±5°C

时间：10±1 sec.

Temp.:260±5°C

Time:10±1 sec

**包装规格 / Packaging SPEC.**

卷盘包装 / REEL

Package Type 封装形式	Units 包装数量					Dimension 包装尺寸 (unit: mm <sup>3</sup> )		
	Units/Reel 只/卷盘	Reels/Inner Box 卷盘/盒	Units/Inner Box 只/盒	Inner Boxes/Outer Box 盒/箱	Units/Outer Box 只/箱	Reel	Inner Box 盒	Outer Box 箱
TO-252	2,500	2	5,000	6	30,000	13" ×16	360×360×50	380×335×366

套管包装 / TUBE

Package Type 封装形式	Units 包装数量					Dimension 包装尺寸 (unit: mm <sup>3</sup> )		
	Units/Tube 只/套管	Tubes/Inner Box 套管/盒	Units/Inner Box 只/盒	Inner Boxes/Outer Box 盒/箱	Units/Outer Box 只/箱	Tube 套管	Inner Box 盒	Outer Box 箱
TO-251/252	75	48	3,600	5	18,000	526×20.5×5.25	555×164×50	575×290×180

**使用说明 / Notices**